

Data Sheet



Article number: 72006150022

Description: Gear Head SG150B I=150
Pinion input

Measures

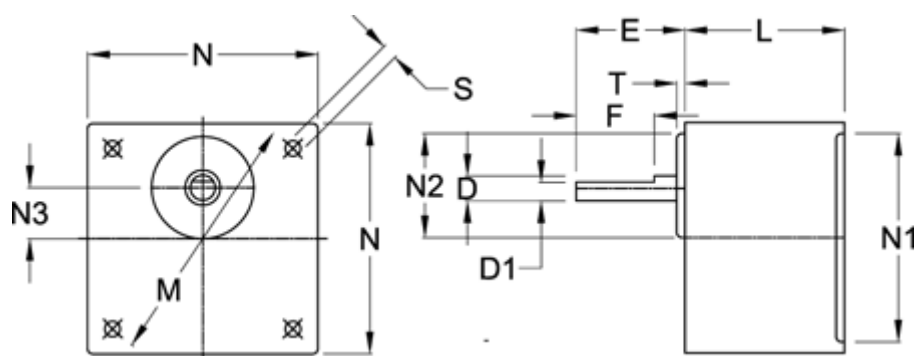

| | |
|--------|------------|
| D = 8 | N2 = 24 |
| D1 = 7 | N3 = 10 |
| E = 32 | S = 4xø4,5 |
| F = 12 | T = 3 |
| L = 40 | |
| M = 70 | |
| N = 60 | |
| N1 = - | |